







# SERIE SPIDER 13.80

TECHNICAL DATA		VERSION		
		STD		
Max working height	m	13,40		
Max height basket floor	m	11,40		
Max side outreach	m	7,80		
Rotation angle	°	360		
Basket size (standard version)	m	1,20 x 0,70		
Basket rotation angle	°	ND		
Max basket capacity	Kg	200		
Lenght in stowed position (with detached basket)	m	4,20		
Min width in stowed position	m	0,78		
Min height in stowed position	m	1,98		
Stabilization footprint	m	2,80 x 2,80		
Max gradeability	deg. / %	16° (29%)		
Max side gradeability	deg. / %	12° (21%)		
Max drive speed	Km/h	3,50		
<b>WEIGHTS</b>		<b>STD</b>		
Weight in working config.*	Kg	1500*		
Ground pressure stowed machine (narrow tracking)	KN/m²	3,06		
Ground pressure when on stabilizers	KN/m²	2,26		
Max point load	KN	11,8		
<b>POWER</b>		<b>STD</b>		
Engine GX270 Honda (Petrol)	hp/rpm'	8/3600	--	--
Engine 1B30 HATZ (diesel)	hp/rpm'	7,2/3600	--	--
Electric motor 230 Vac	hp/kW	3 / 2,2		--
Electric motor 24 Vdc	hp/kW	--		--
Battery capacity 24Vdc Lead Acid	Ah	--		
Battery capacity 24Vdc Lithium-Ion	Ah	--		
Battery charger (Lead/acid batt)	Ah	--		
Battery charger (Lithium/Ion)	Ah	--		

\* Some weights may differ due to the chosen optionals.



+



### STD

- Combustion engine
- Electric motor-pump single phase 230/110Vac

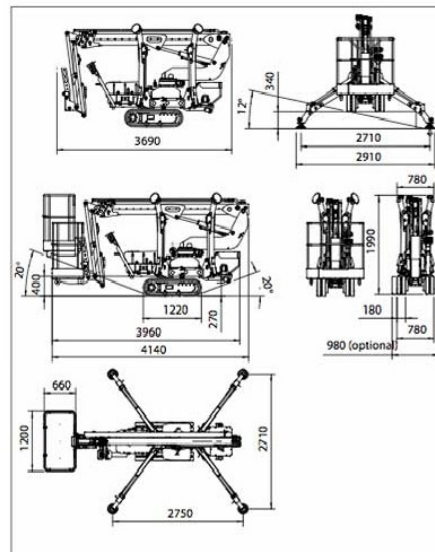

REPI del 15-07-2015 DATI, DIMENSIONI E CARATTERISTICHE SONO FORNITI A TITOLO INDICATIVO E NON IMPEDIVANO